

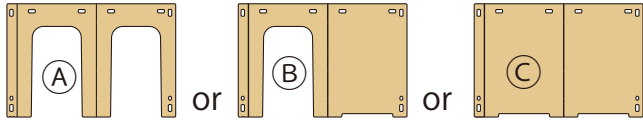

ダンボールめいろ 組立て方説明書



のうち2枚を使ってまずは1マスを組み立てます。

(例としてAとCで1マスの組み立て方を説明します。)

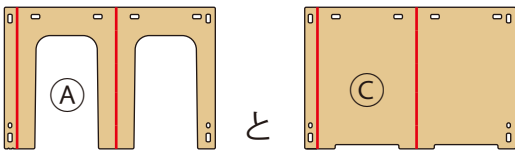

の左図の赤色部の線を90度に折り曲げ、

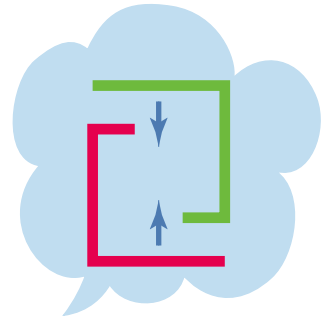

真上から見えます→

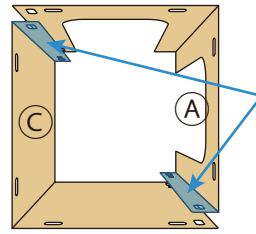

短い面が内側になるように!

折った2枚を

左図のように重ねます。

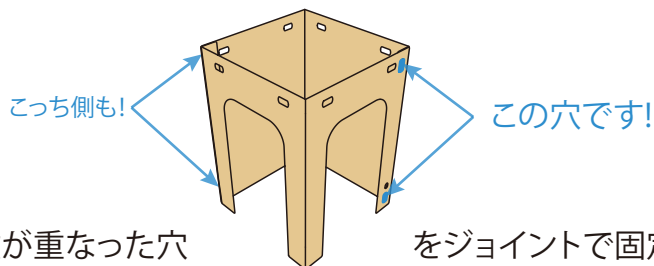

そして2枚が重なった穴

をジョイントで固定します。



ジョイントの止め方は、

穴を合わせて...

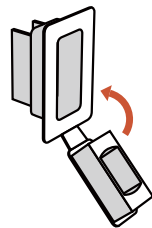

パチッと止めるだけ!

すべてのマスを組立て終わったら、

マスどうしも重なった穴

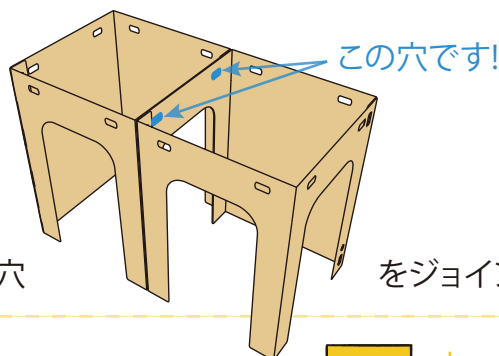

をジョイントで止めてつなげてください。



hacomo 株式会社

〒769-2701 香川県東かがわ市湊 1858

TEL:0879-23-0055 FAX:0879-23-0056



6マス×6マス Aパターン 経路図

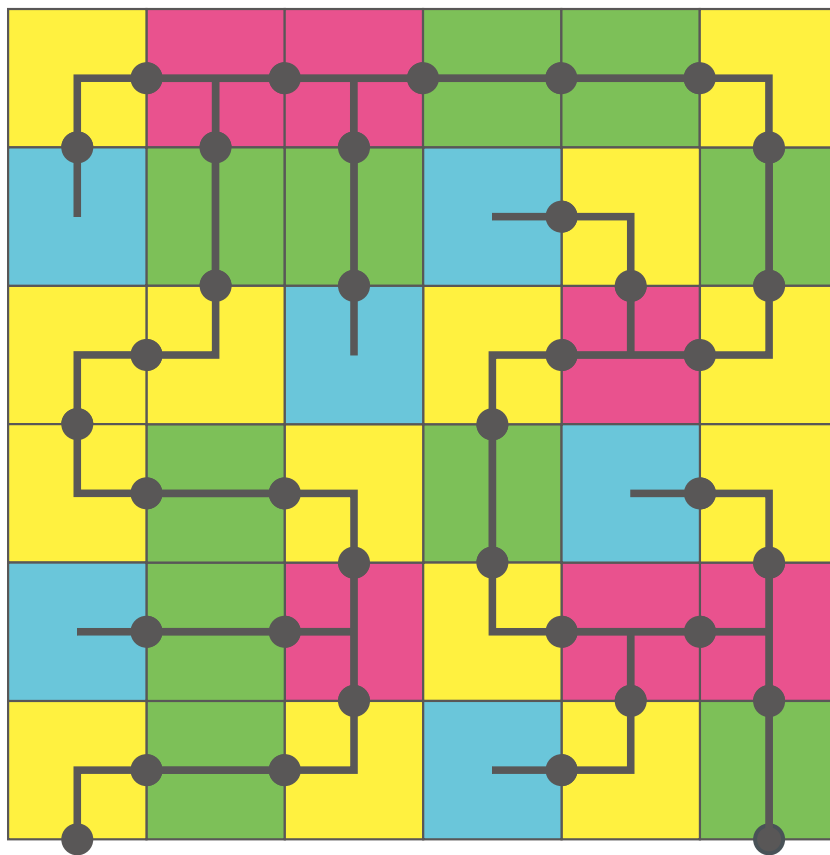

ゴール!!

スタート!!

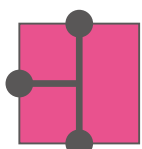

6マス

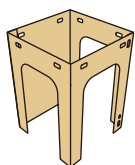

=

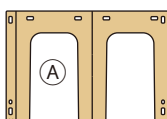

6枚

+

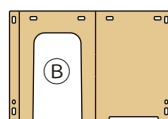

6枚

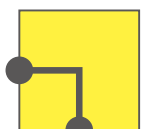

14マス

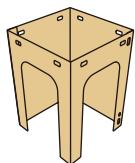

=

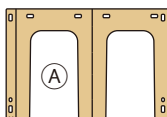

14枚

+

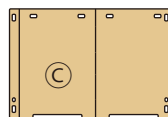

14枚



10マス

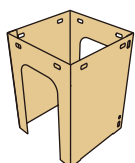

=

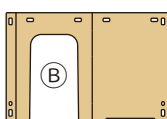

10枚

+

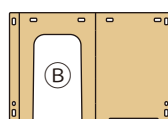

10枚



6マス

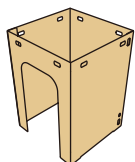

=

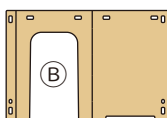

6枚

+

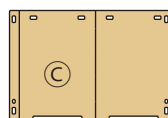

6枚

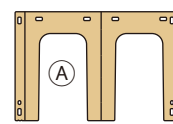

20枚+(予備1枚)

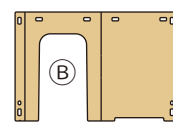

32枚+(予備1枚)

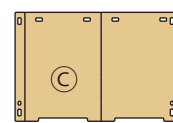

20枚+(予備1枚)

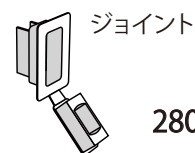

280個



タンボール
めいろ

6マス×6マス Bパターン 経路図

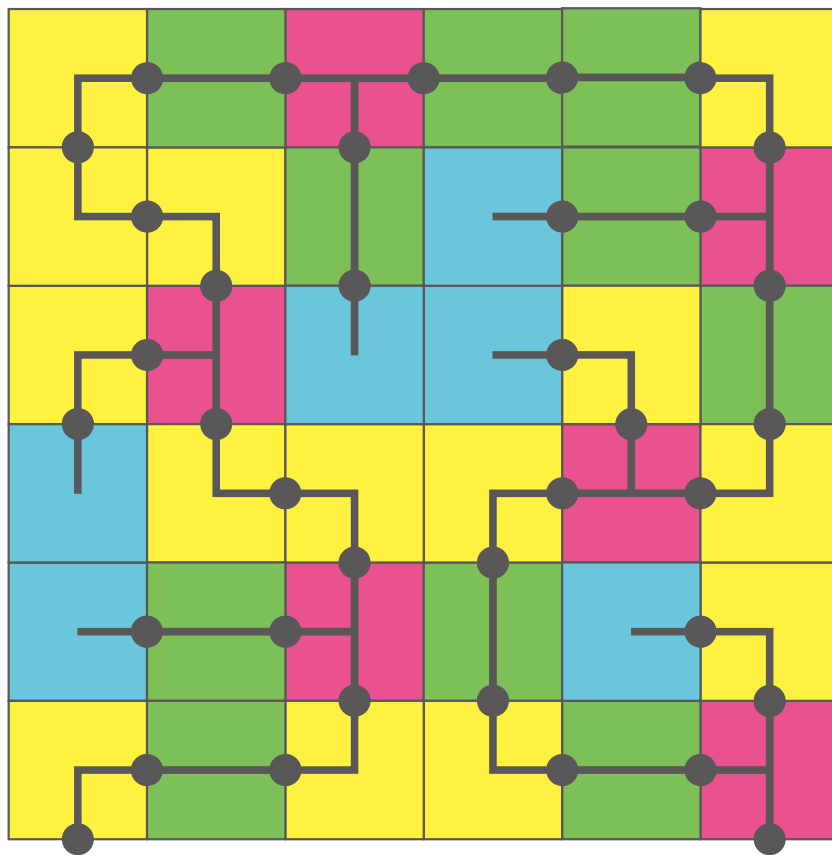

ゴール!!

スタート!!

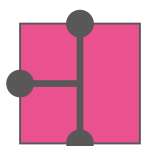

6マス

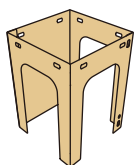

=

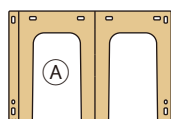

6枚

+

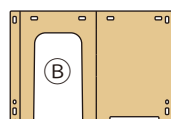

6枚



14マス

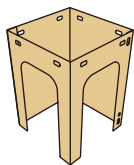

=

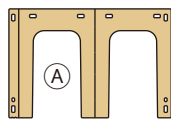

14枚

+

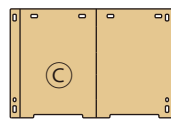

14枚



10マス

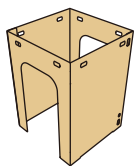

=

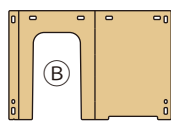

10枚

+

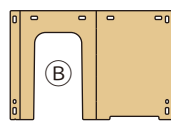

10枚



6マス

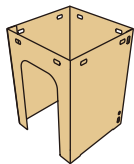

=

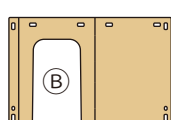

6枚

+

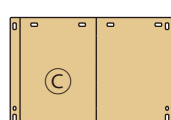

6枚

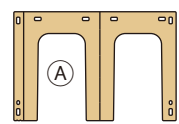

20枚+(予備1枚)

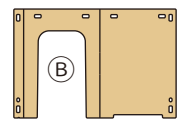

32枚+(予備1枚)

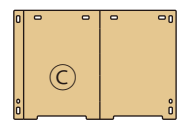

20枚+(予備1枚)

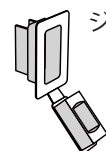

ジョイント

280個



タンホール
めいろ

6マス×6マス Cパターン 経路図

ゴール!!

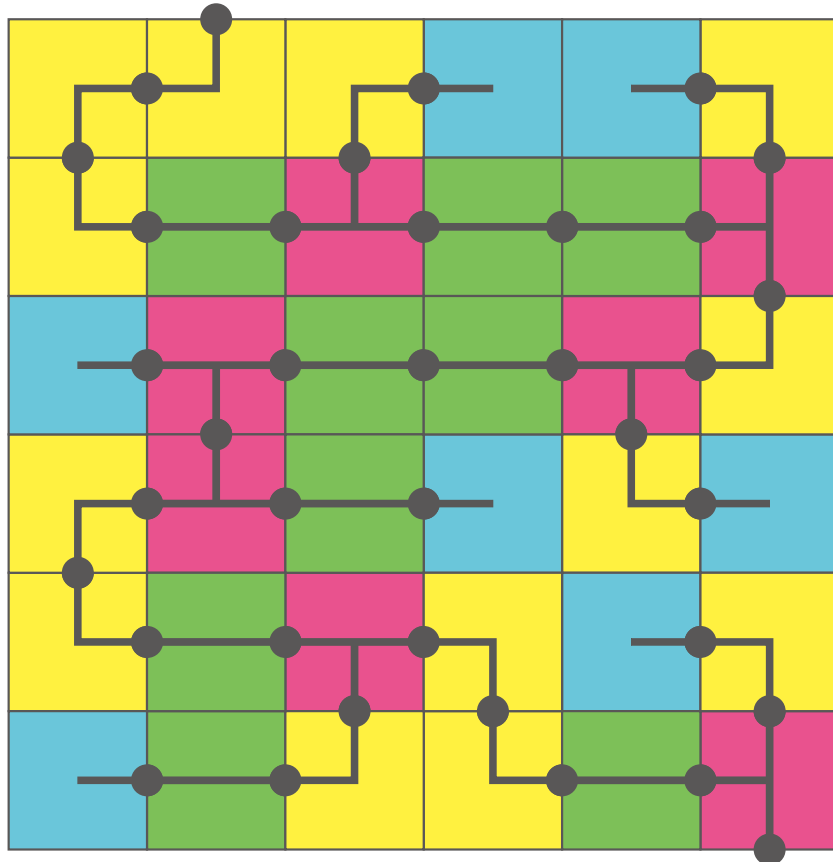

スタート!!

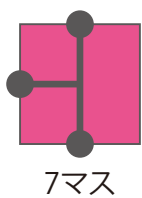

7マス

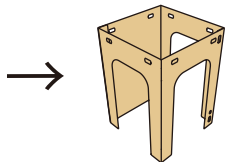

=

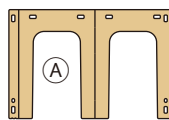

7枚

+

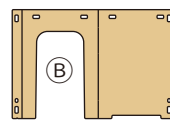

7枚

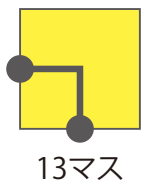

13マス

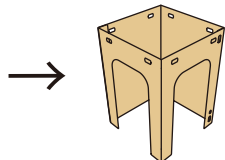

=

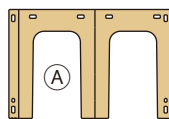

13枚

+

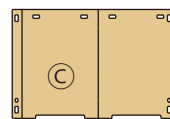

13枚

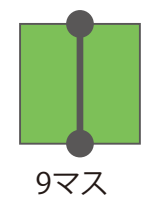

9マス

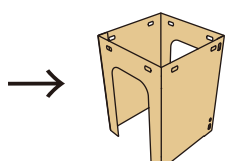

=

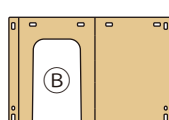

9枚

+

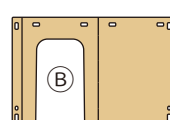

9枚

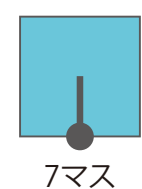

7マス

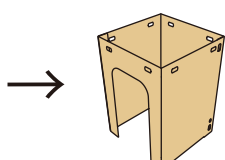

=

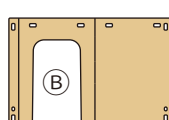

7枚

+

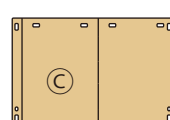

7枚

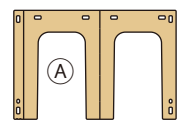

20枚+(予備1枚)

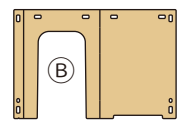

32枚+(予備1枚)

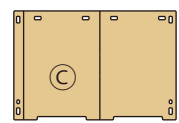

20枚+(予備1枚)

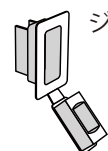

ジョイント

280個



タンボール
めいろ

6マス×6マス Dパターン 経路図

ゴール!!

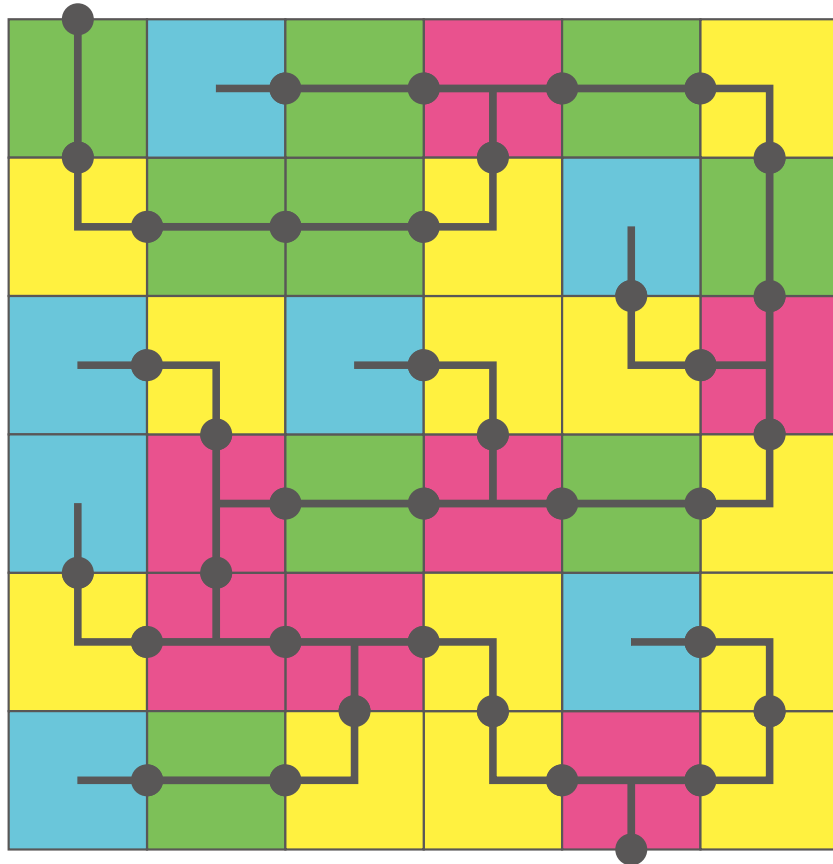

スタート!!

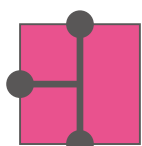

7マス

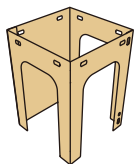

=

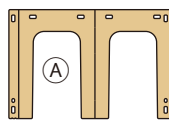

7枚

+

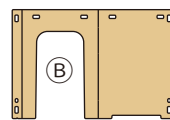

7枚

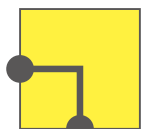

13マス

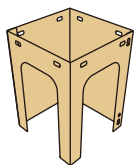

=

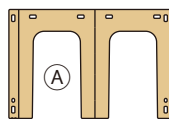

13枚

+

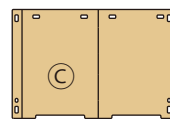

13枚



9マス

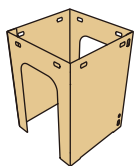

=

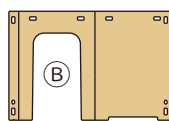

9枚

+

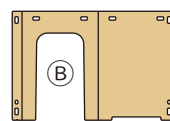

9枚

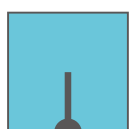

7マス

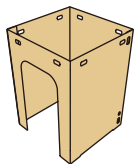

=

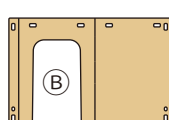

7枚

+

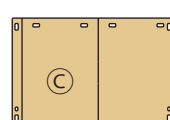

7枚

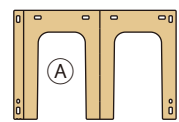

20枚+(予備1枚)

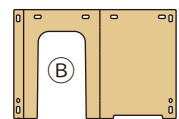

32枚+(予備1枚)

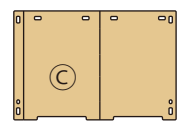

20枚+(予備1枚)

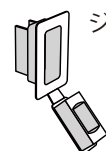

ジョイント

280個



タンボール
めいろ

6マス×6マス Eパターン 経路図

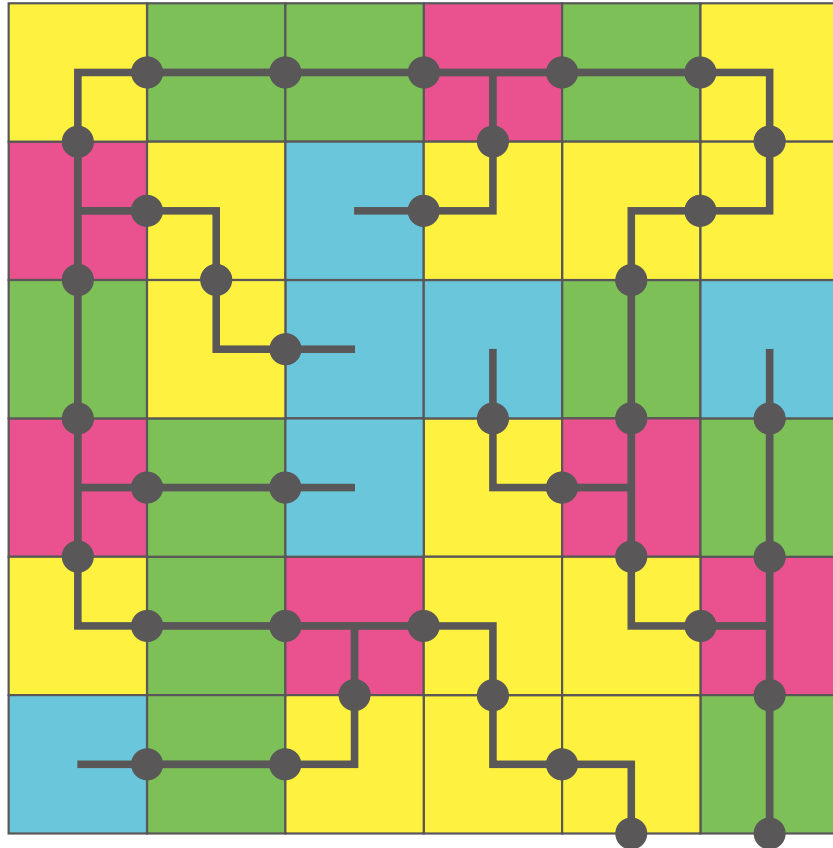

ゴール!! スタート!!

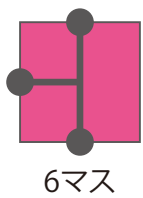

6マス

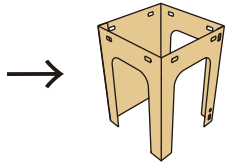

=

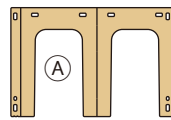

6枚

+

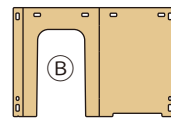

6枚

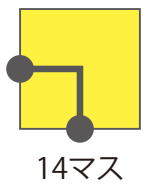

14マス

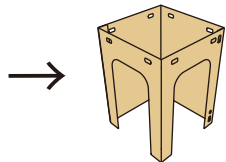

=

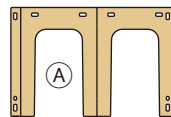

14枚

+

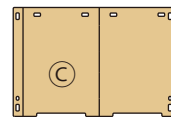

14枚



10マス

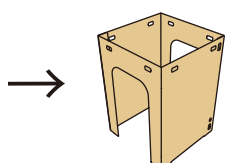

=

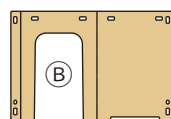

10枚

+

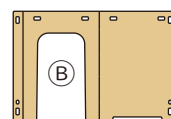

10枚



6マス

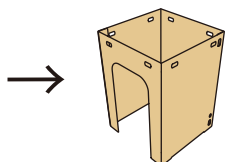

=

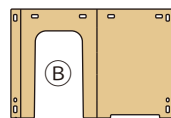

6枚

+

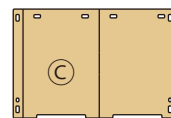

6枚

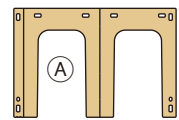

20枚+(予備1枚)

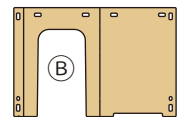

32枚+(予備1枚)

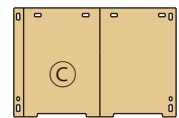

20枚+(予備1枚)

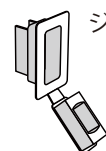

ジョイント

280個