

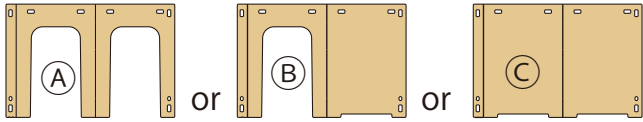

ダンボールめいろ 組立て方説明書



のうち2枚を使ってまずは1マスを組み立てます。

(例としてAとCで1マスの組み立て方を説明します。)

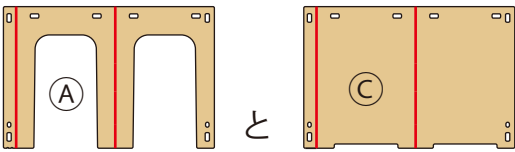

の左図の赤色部の線を90度に折り曲げ、

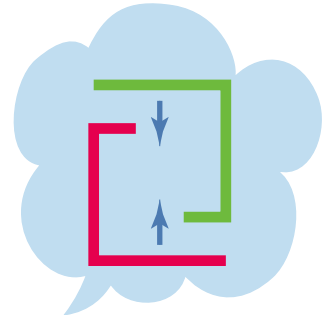

真上から見てます→

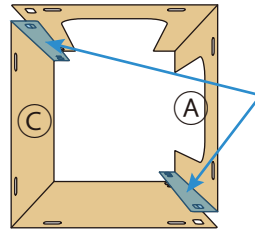

短い面が内側になるように!

折った2枚を

左図のように重ねます。

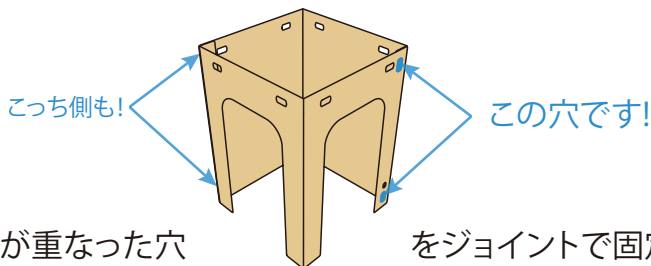

そして2枚が重なった穴

をジョイントで固定します。



ジョイントの止め方は、

穴を合わせて...

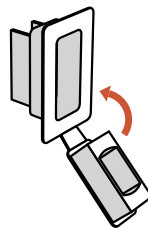

パチッと止めるだけ!

すべてのマスを組立て終わったら、

マスどうしも重なった穴

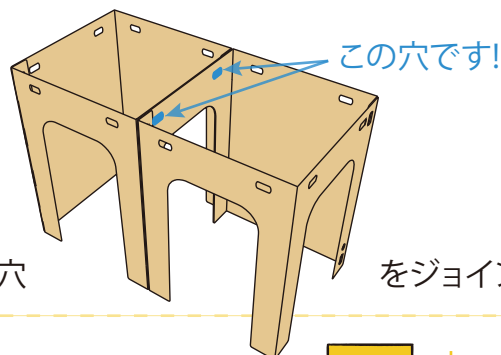

をジョイントで止めてつなげてください。



hacomo 株式会社

〒769-2701 香川県東かがわ市湊 1858

TEL:0879-23-0055 FAX:0879-23-0056



8マス×8マス Aパターン 経路図

非常口

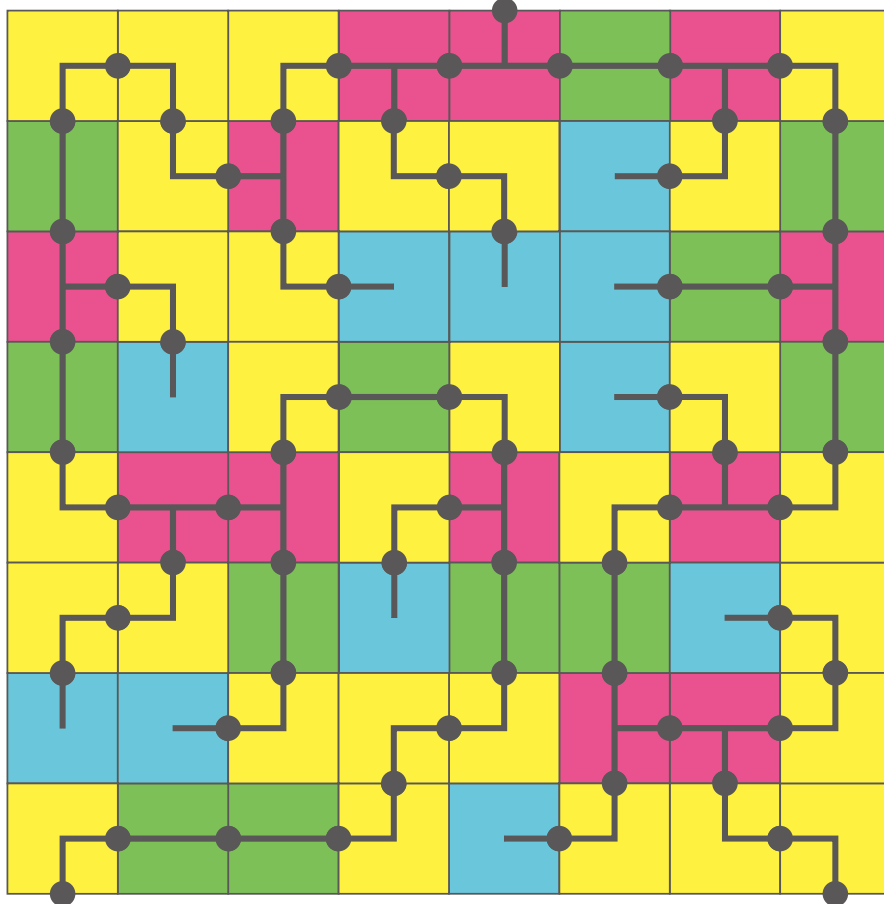

ゴール!!

スタート!!

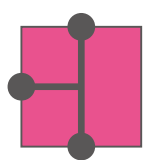

12マス

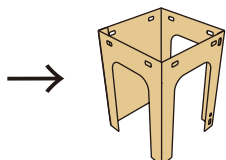

=

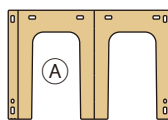

12枚

+

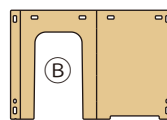

12枚

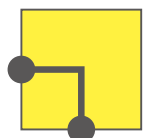

29マス

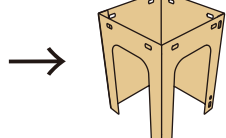

=

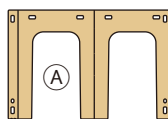

29枚

+

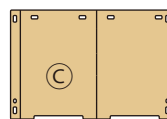

29枚



12マス

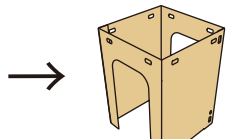

=

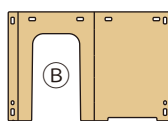

12枚

+

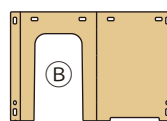

12枚

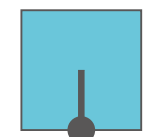

11マス

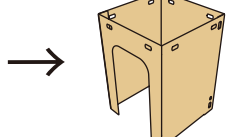

=

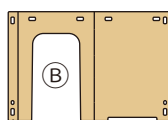

11枚

+

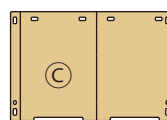

11枚

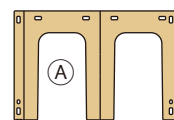

41枚+(予備1枚)

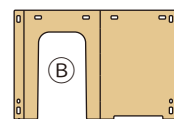

47枚+(予備1枚)

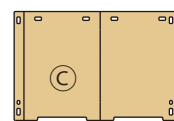

40枚+(予備1枚)

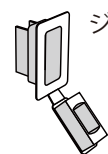

ジョイント

510個



8マス×8マス Bパターン 経路図

非常口

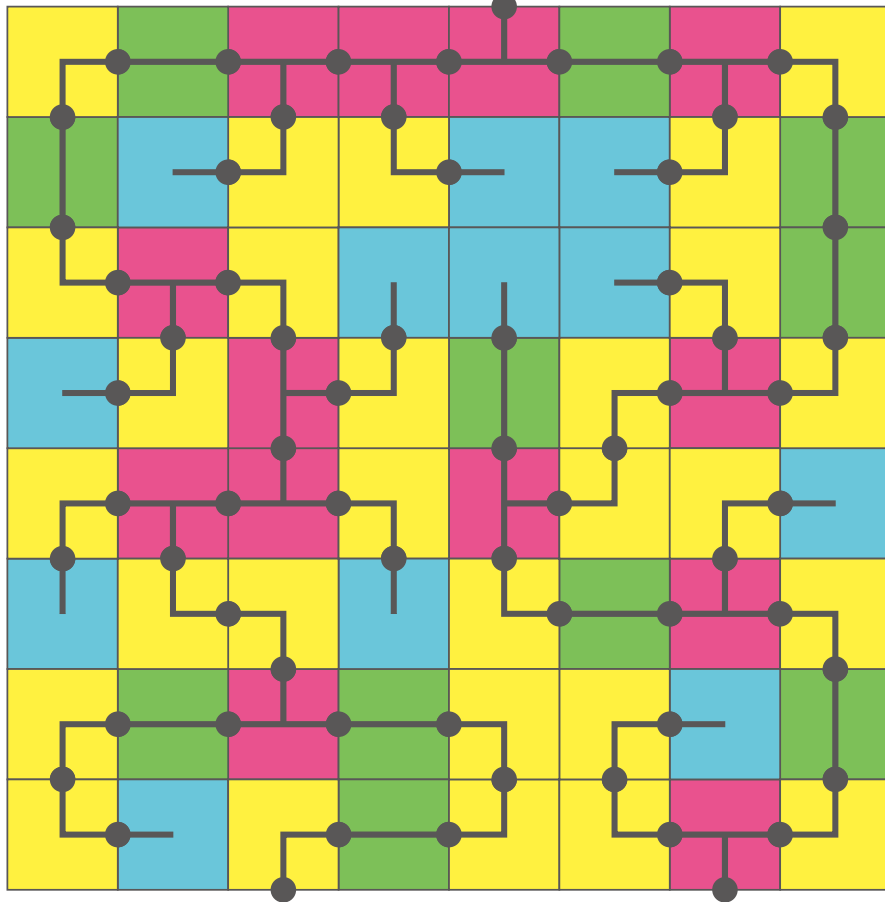

ゴール!!

スタート!!

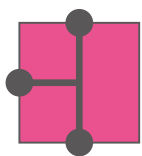

13マス

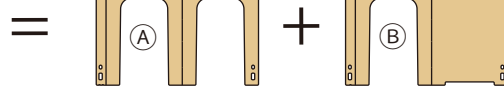
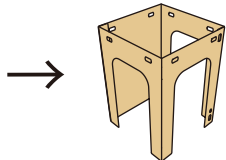

13枚

13枚

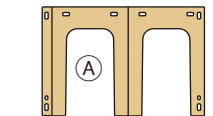

41枚+(予備1枚)



28マス

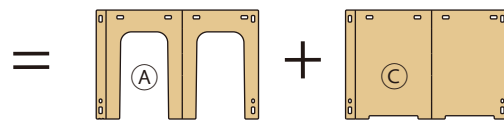
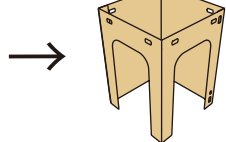

28枚

28枚

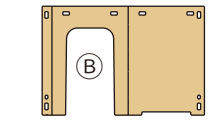

47枚+(予備1枚)



11マス

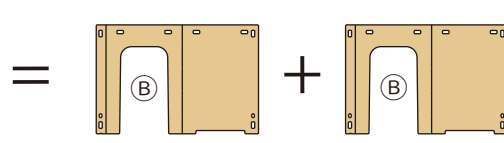
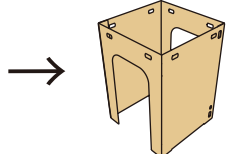

11枚

11枚

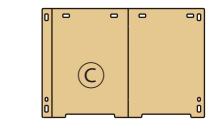

40枚+(予備1枚)

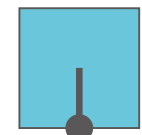

12マス

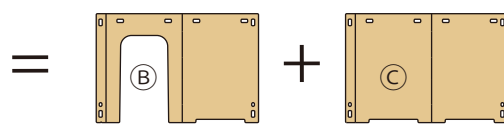
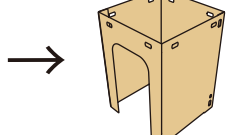

12枚

12枚

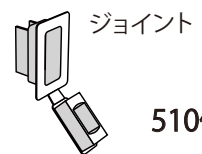

ジョイント

510個



タンボール
めいろ

8マス×8マス Cパターン 経路図

ゴール!!

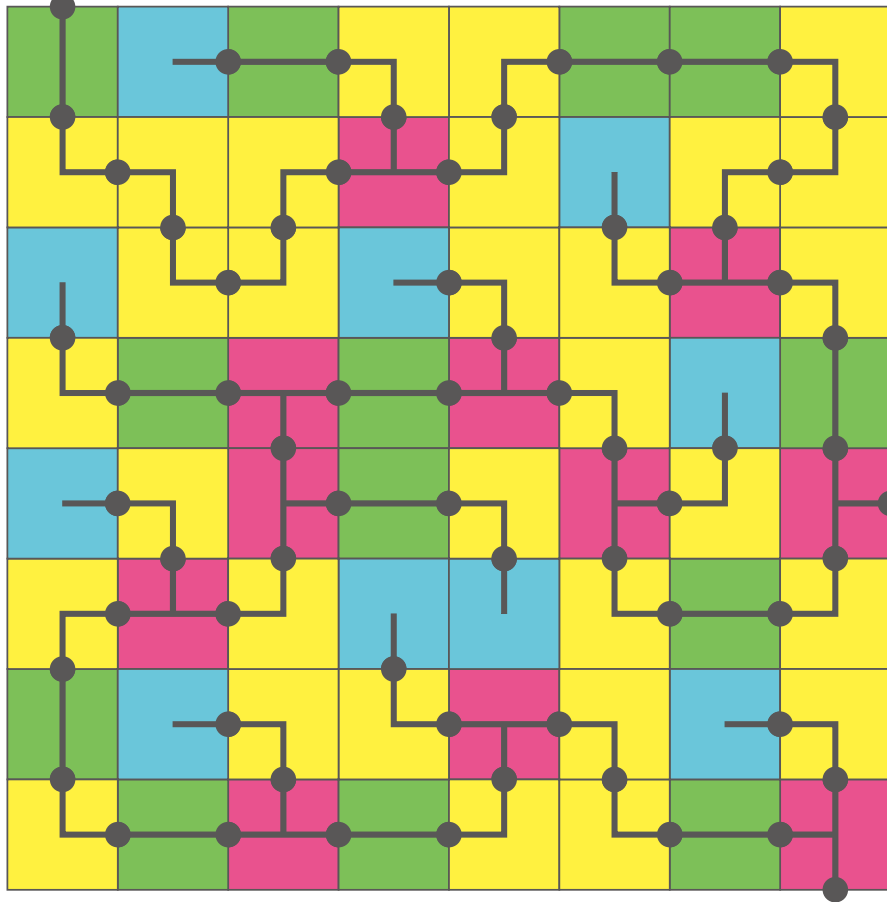

非常口

スタート!!

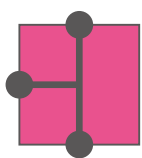

11マス

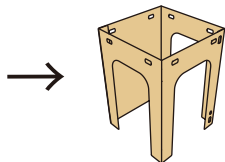

=

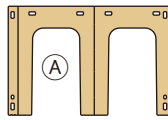

11枚

+

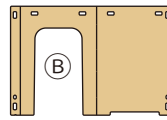

11枚

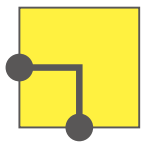

30マス

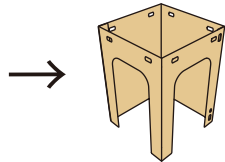

=

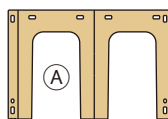

30枚

+

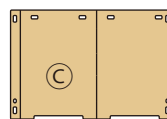

30枚



13マス

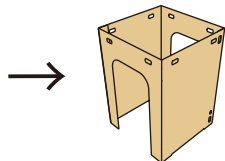

=

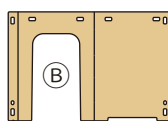

13枚

+

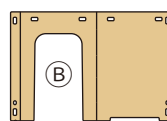

13枚

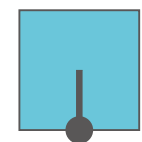

10マス

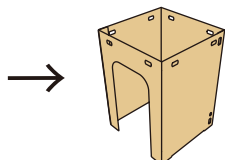

=

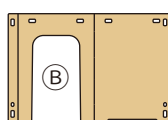

10枚

+

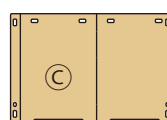

10枚

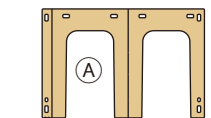

41枚+(予備1枚)

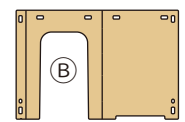

47枚+(予備1枚)

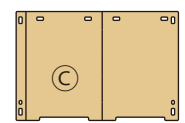

40枚+(予備1枚)

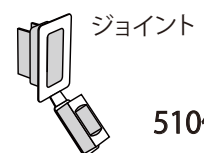

ジョイント

510個



タンボール
めいろ

8マス×8マス Dパターン 経路図

ゴール!!

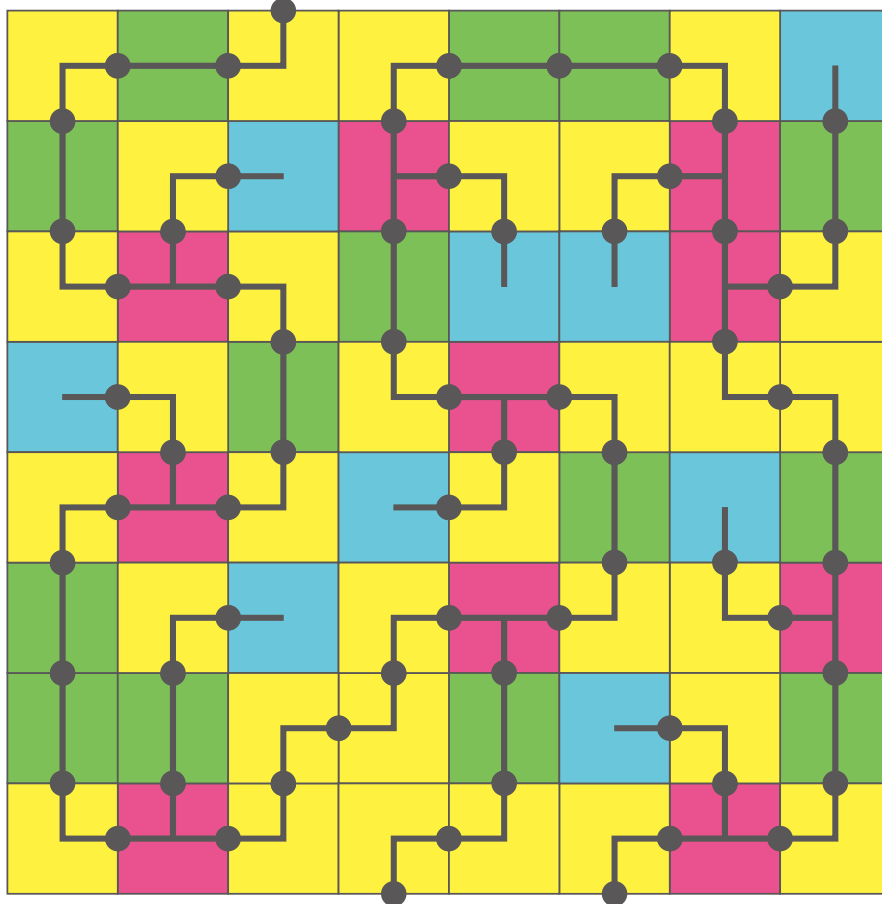

非常口 スタート!!

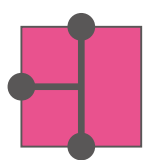

10マス

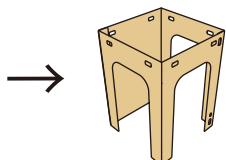

=

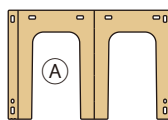

10枚

+

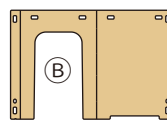

10枚

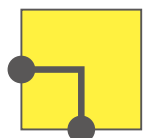

31マス

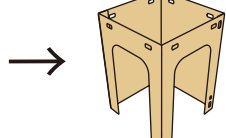

=

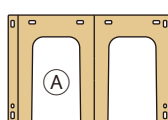

31枚

+

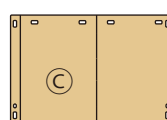

31枚



14マス

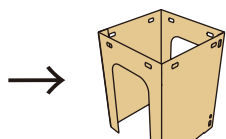

=

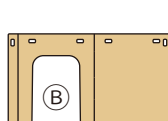

14枚

+

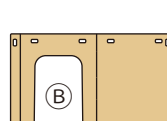

14枚

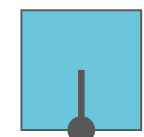

9マス

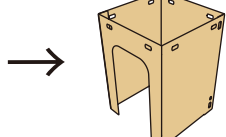

=

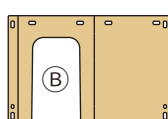

9枚

+

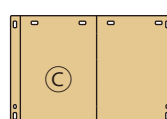

9枚

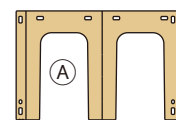

41枚+(予備1枚)

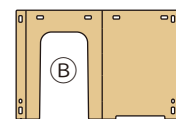

47枚+(予備1枚)

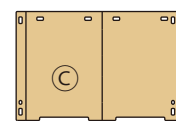

40枚+(予備1枚)

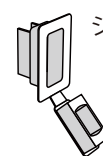

ジョイント

510個



8マス×8マス Eパターン 経路図

非常口

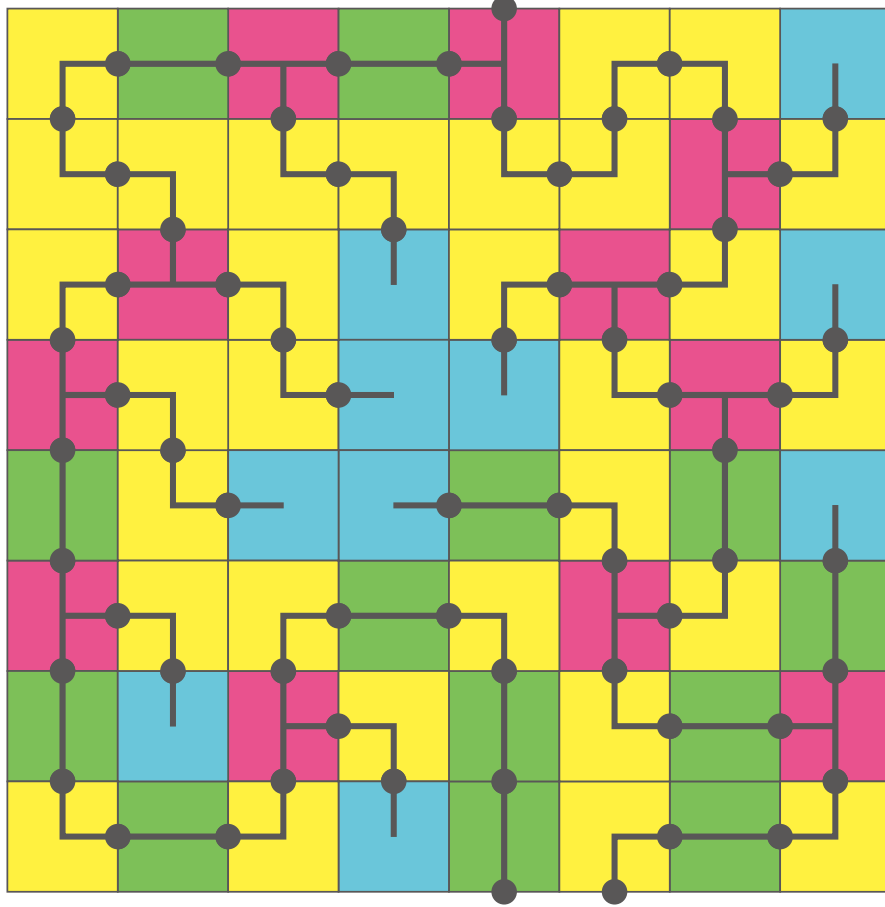

ゴール!! スタート!!

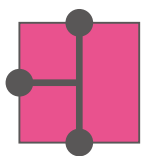

11マス

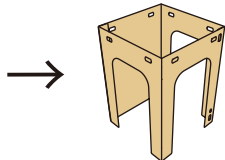

=

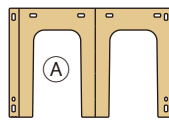

11枚

+

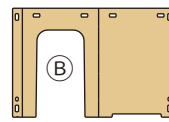

11枚



30マス

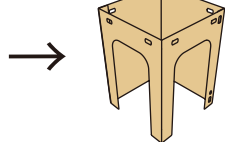

=

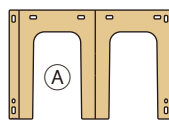

30枚

+

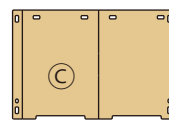

30枚



13マス

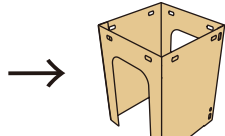

=

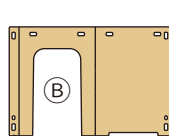

13枚

+

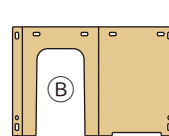

13枚



10マス

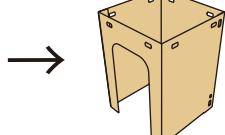

=

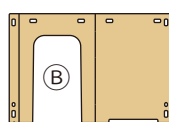

10枚

+

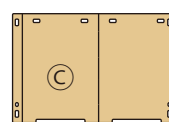

10枚

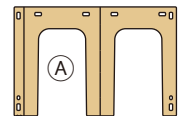

41枚+(予備1枚)

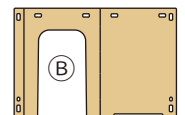

47枚+(予備1枚)

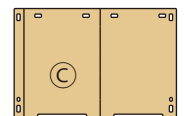

40枚+(予備1枚)

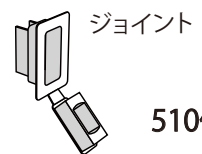

510個