

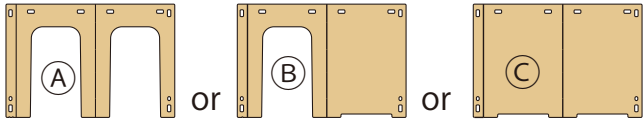

# ダンボールめいろ 組立て方説明書



のうち2枚を使ってまずは1マスを組み立てます。

(例としてAとCで1マスの組み立て方を説明します。)

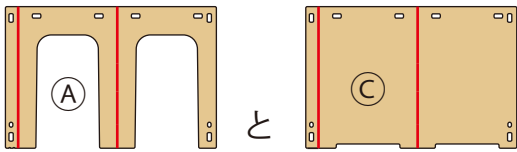

の左図の赤色部の線を90度に折り曲げ、

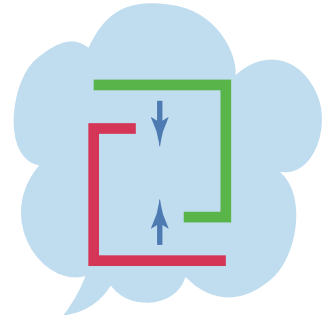

真上から見てます→

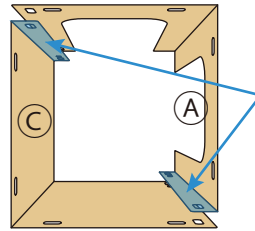

短い面が内側になるように!

折った2枚を

左図のように重ねます。

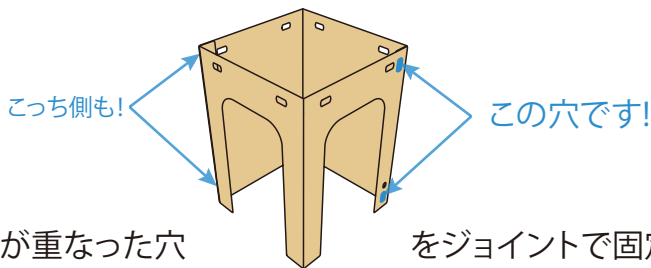

そして2枚が重なった穴

をジョイントで固定します。

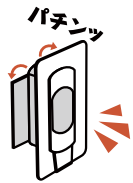
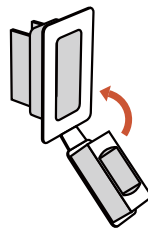

ジョイントの止め方は、

穴を合わせて...

パチッと止めるだけ!

すべてのマスを組立て終わったら、

マスどうしも重なった穴

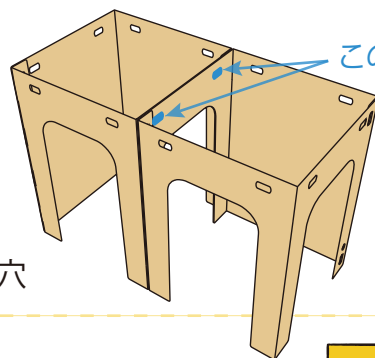

この穴です!

をジョイントで止めてつなげてください。



hacomo 株式会社

〒769-2701 香川県東かがわ市湊 1858

TEL:0879-23-0055 FAX:0879-23-0056



# 5マス×5マス Aパターン 経路図

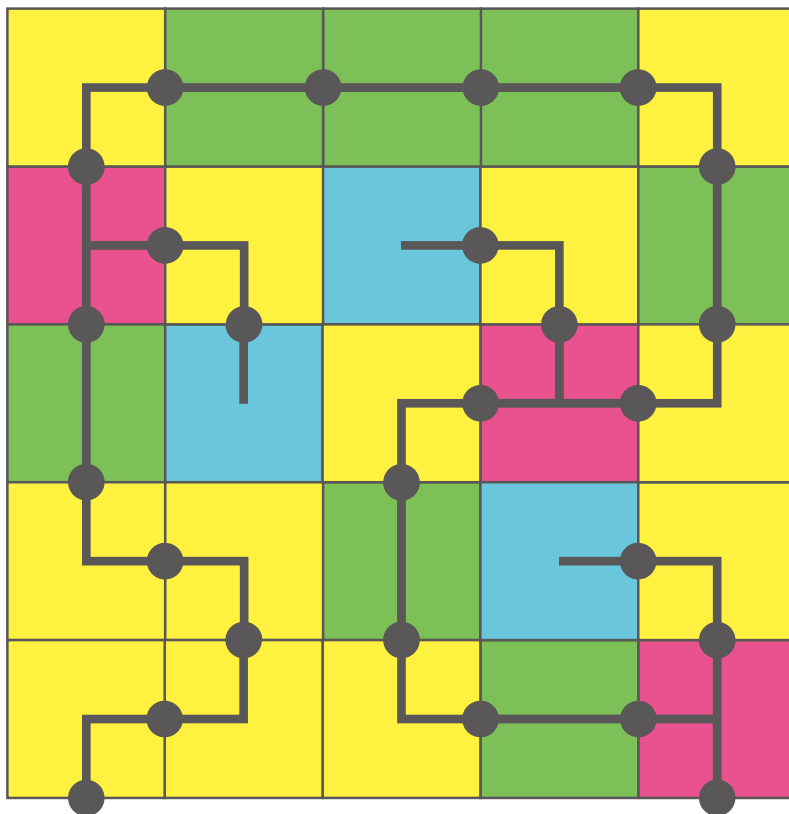

ゴール!!

スタート!!

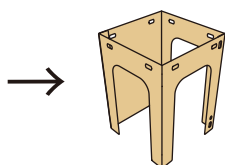
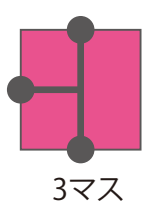

=

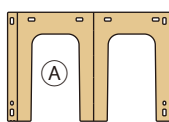

+

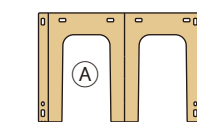
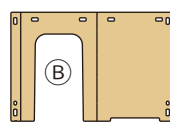

15枚+(予備1枚)

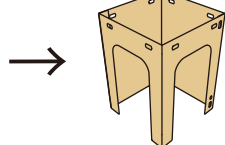
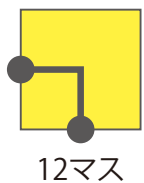

=

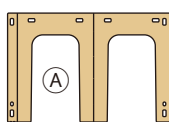

+

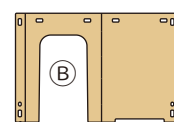
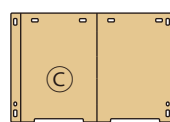

20枚+(予備1枚)

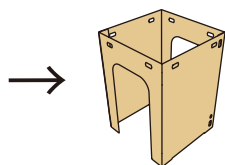
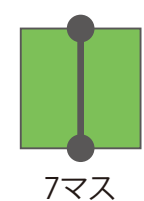

=

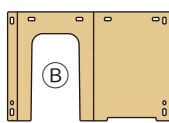

+

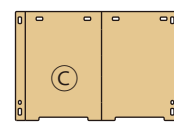
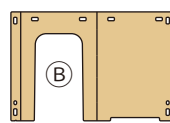

15枚+(予備1枚)

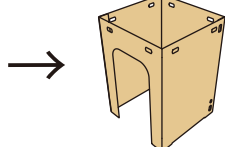
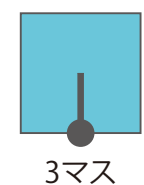

=

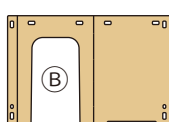

+

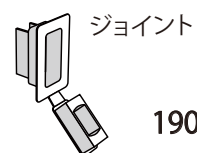
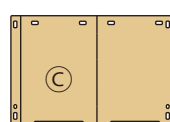



# 5マス×5マス Bパターン 経路図

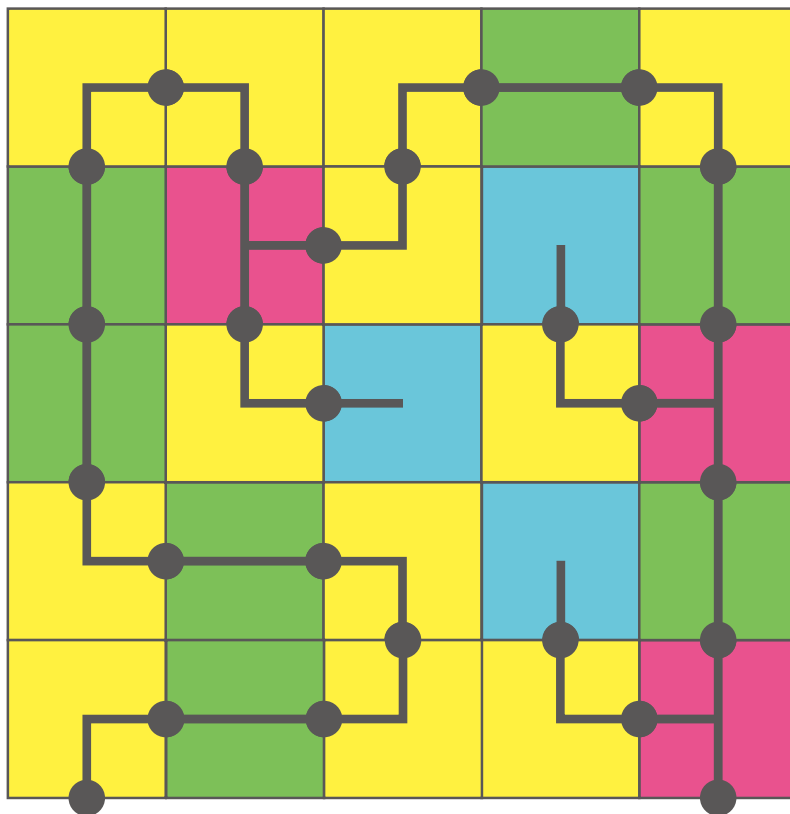

ゴール!!

スタート!!

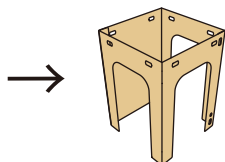
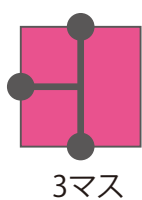

=

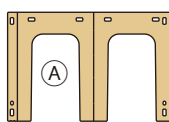

+

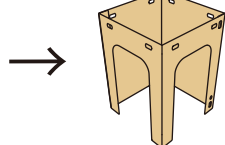
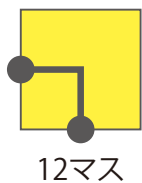
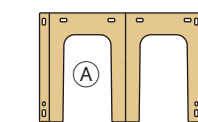
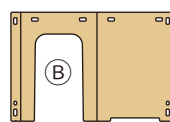

=

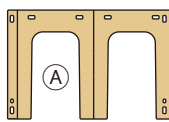

+

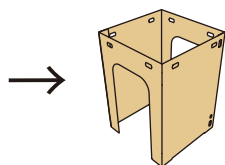
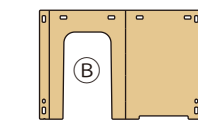
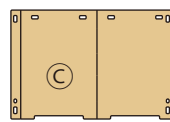

=

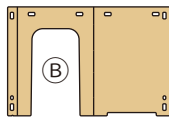

+

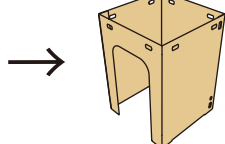
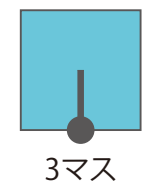
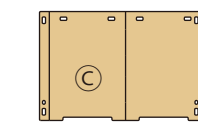
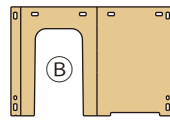

=

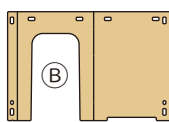

+

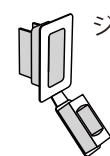
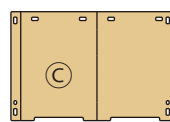

ジョイント

190個



タンボール  
めいろ

# 5マス×5マス Cパターン 経路図

## ゴール!!

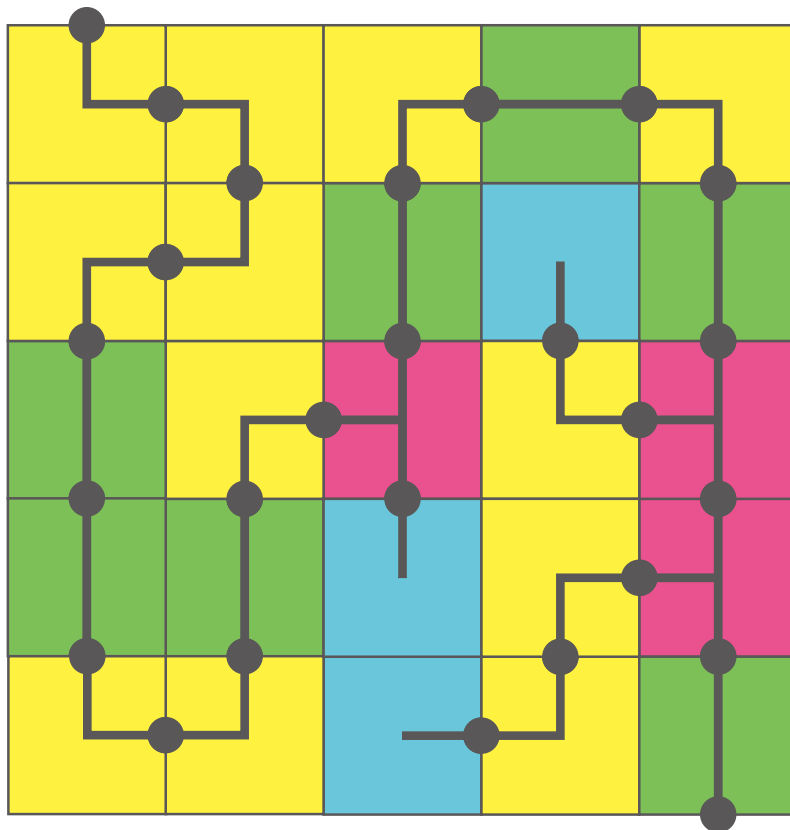

## スタート!!

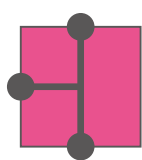

3マス

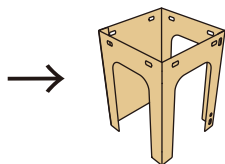

=

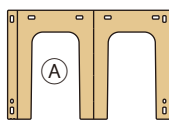

3枚

+

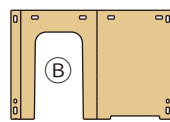

3枚

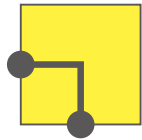

12マス

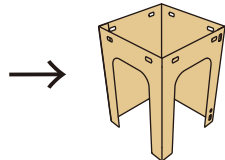

=

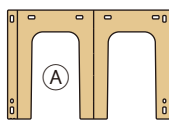

12枚

+

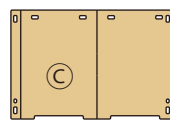

12枚



7マス

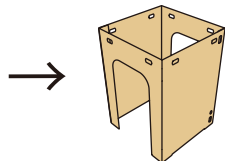

=

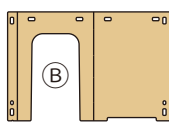

7枚

+

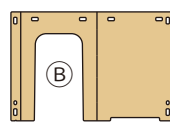

7枚

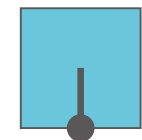

3マス

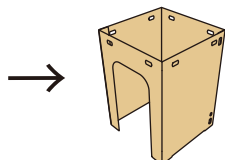

=

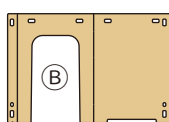

3枚

+

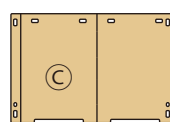

3枚

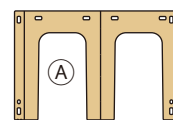

15枚+(予備1枚)

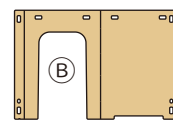

20枚+(予備1枚)

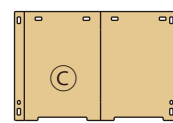

15枚+(予備1枚)

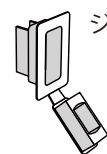

ジョイント

190個



# 5マス×5マス Dパターン 経路図

ゴール!!

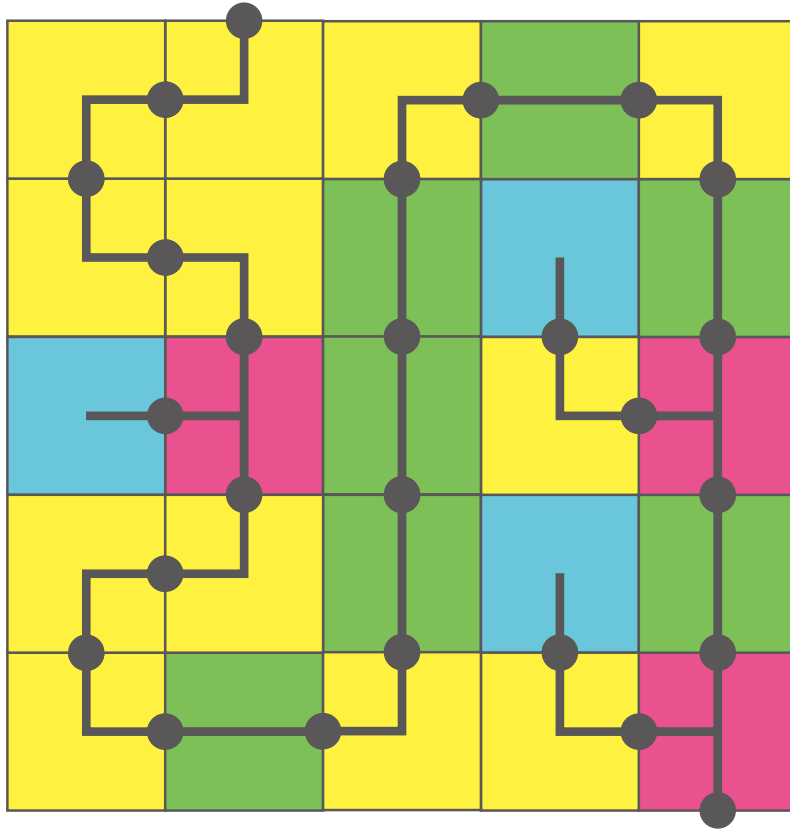

スタート!!

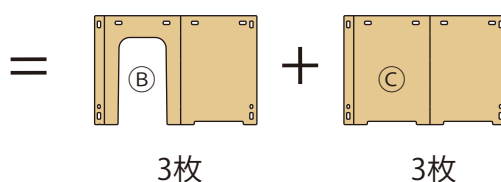
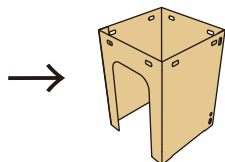
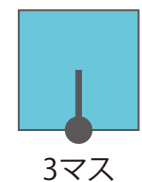
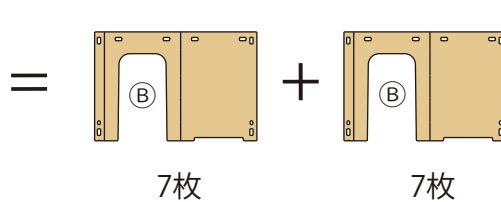
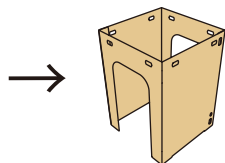
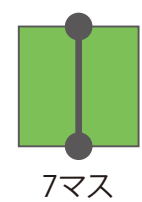
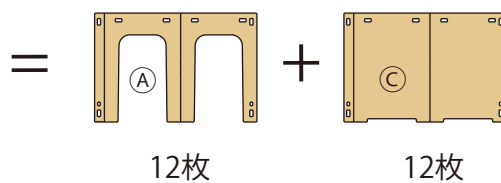
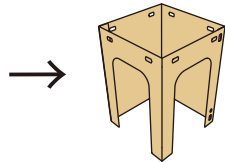
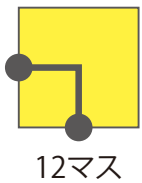
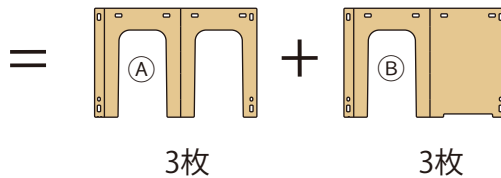
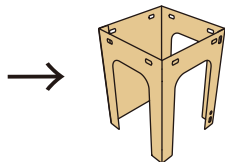
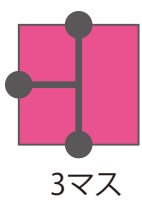

15枚+(予備1枚)

---

20枚+(予備1枚)

---

15枚+(予備1枚)

---

ジョイント  
190個



# 5マス×5マス Eパターン 経路図

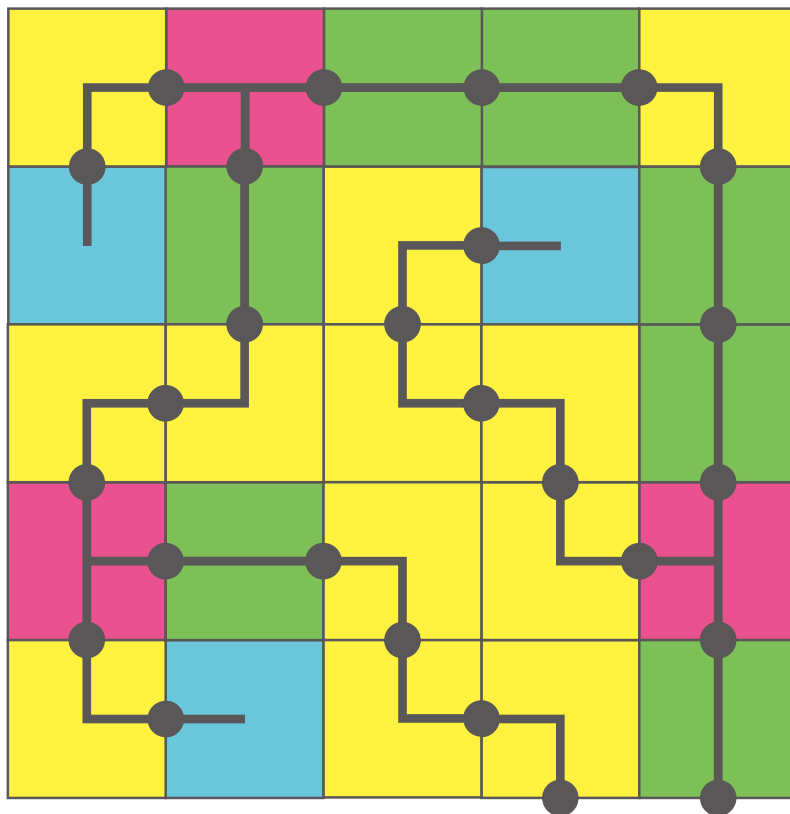

ゴール!! スタート!!

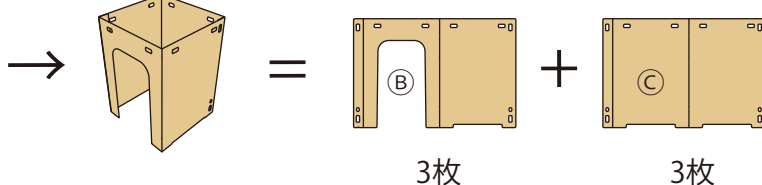
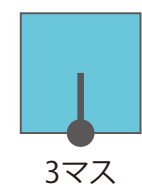
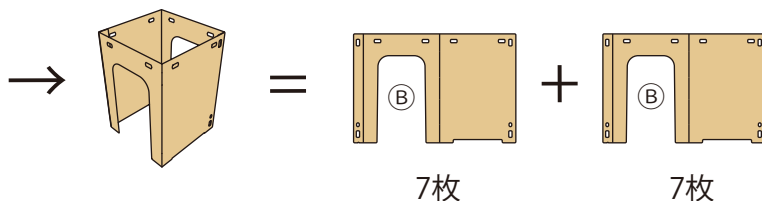
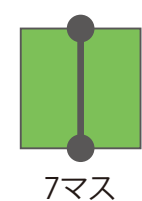
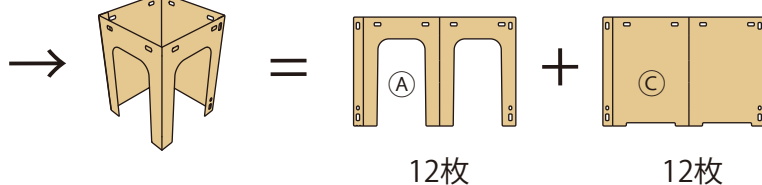
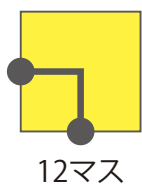
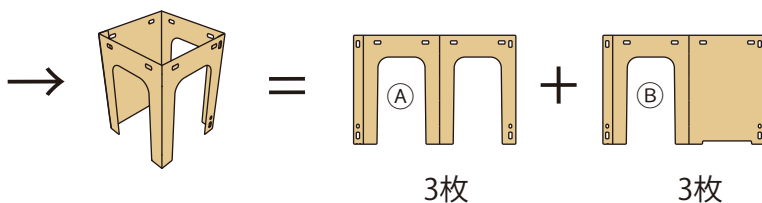
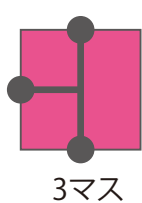

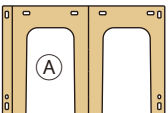

15枚+(予備1枚)

---

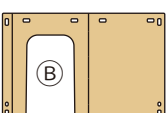

20枚+(予備1枚)

---

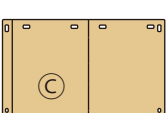

15枚+(予備1枚)

---

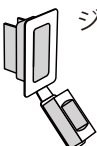

ジョイント  
190個