

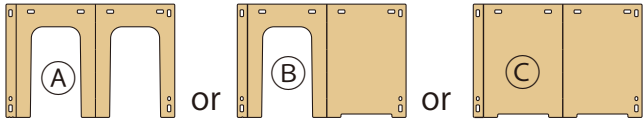

ダンボールめいろ 組立て方説明書



のうち2枚を使ってまずは1マスを組み立てます。

(例としてAとCで1マスの組み立て方を説明します。)

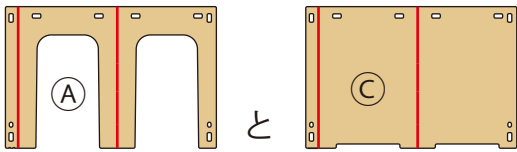

の左図の赤色部の線を90度に折り曲げ、

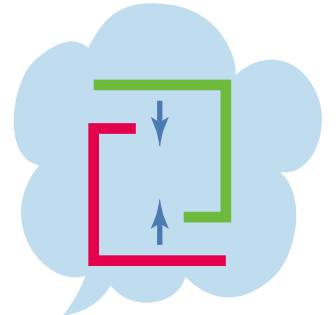

真上から見てます→

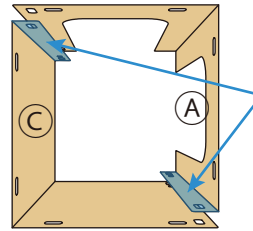

短い面が内側になるように!

折った2枚を

左図のように重ねます。

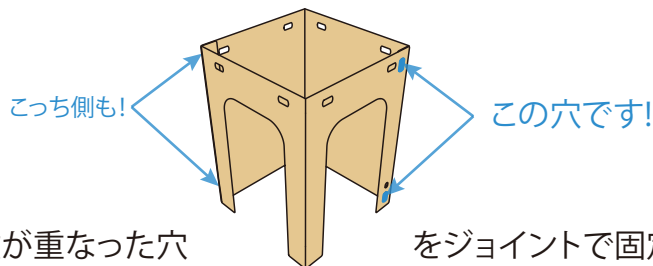

そして2枚が重なった穴

をジョイントで固定します。

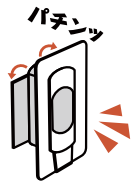
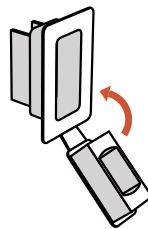

ジョイントの止め方は、

穴を合わせて...

パチッと止めるだけ!

すべてのマスを組立て終わったら、

マスどうしも重なった穴

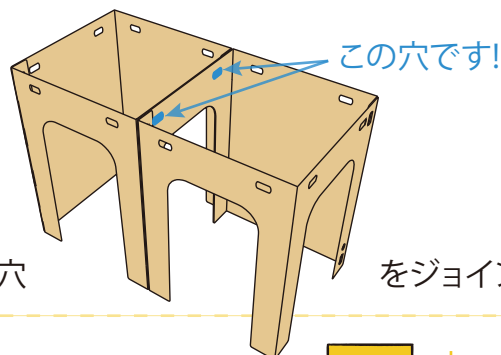

をジョイントで止めてつなげてください。



hacomo 株式会社

〒769-2701 香川県東かがわ市湊 1858

TEL:0879-23-0055 FAX:0879-23-0056



7マス×7マス Aパターン 経路図

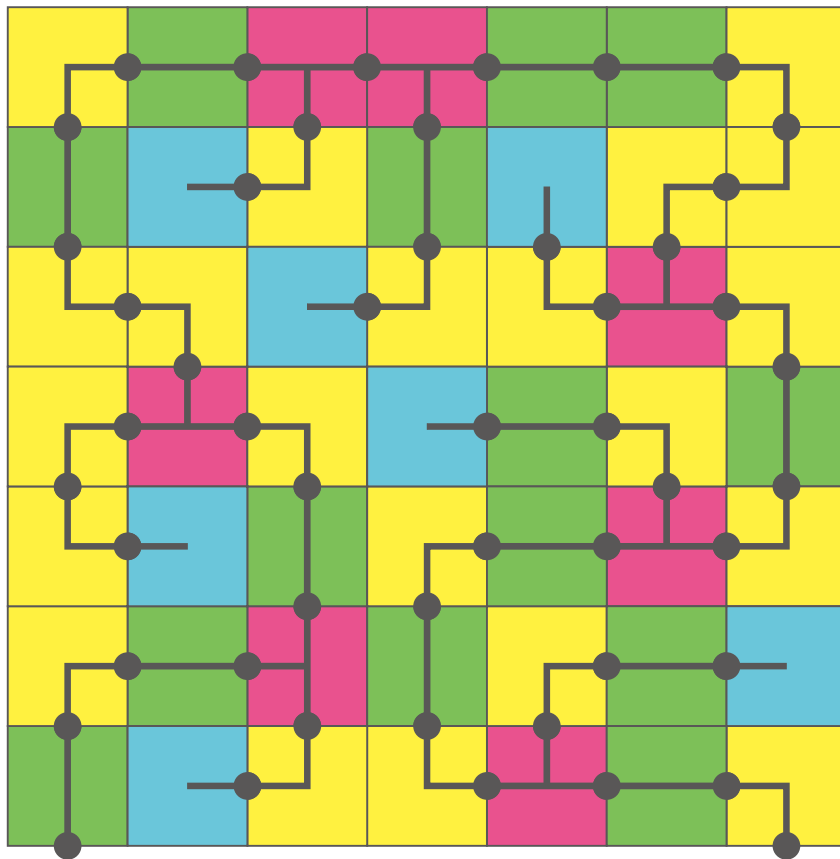

ゴール!!

スタート!!

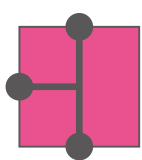

7マス

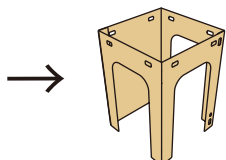

=

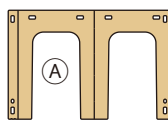

7枚

+

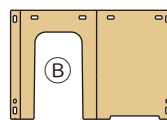

7枚



21マス

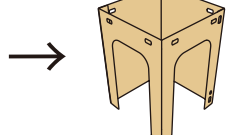

=

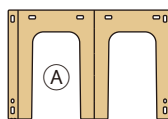

21枚

+

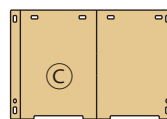

21枚



14マス

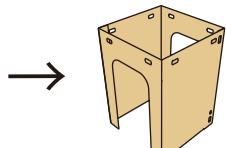

=

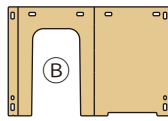

14枚

+

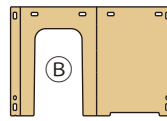

14枚



7マス

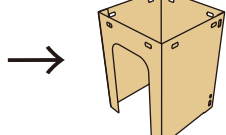

=

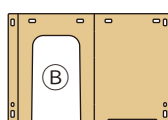

7枚

+

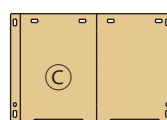

7枚

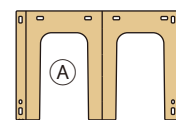

28枚+(予備1枚)

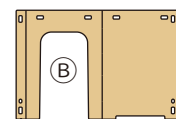

42枚+(予備1枚)

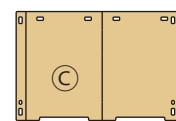

28枚+(予備1枚)

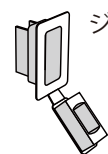

ジョイント

390個



7マス×7マス Bパターン 経路図

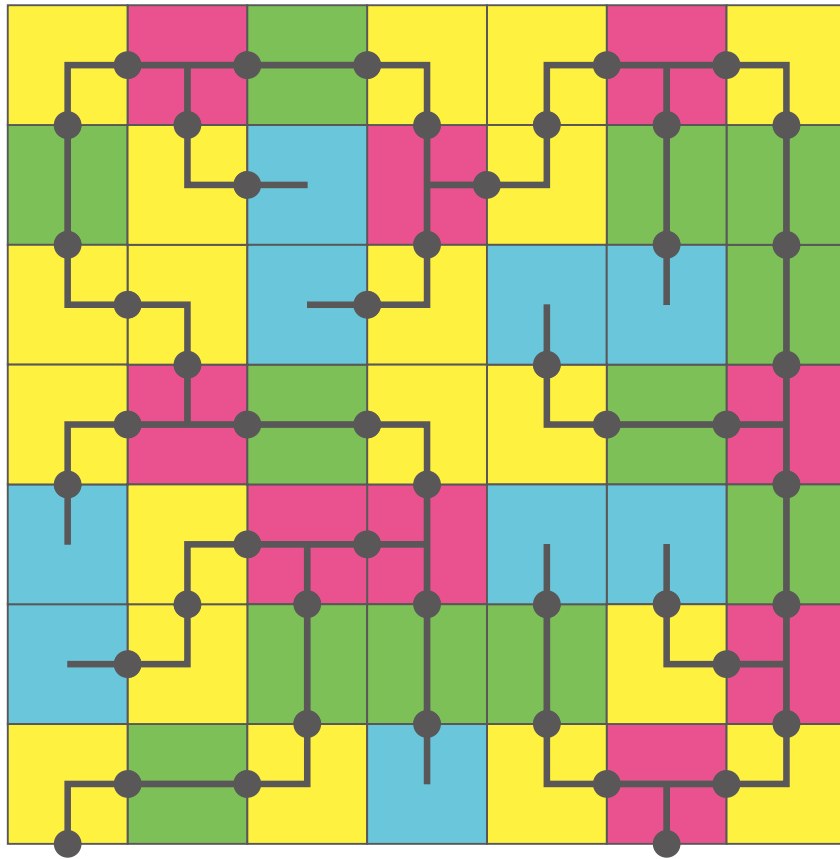

ゴール!!

スタート!!

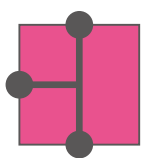

9マス

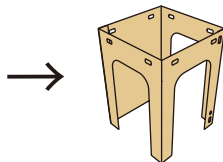

=

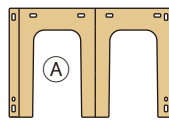

9枚

+

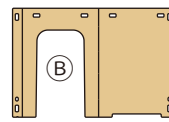

9枚



19マス

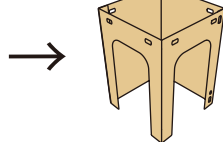

=

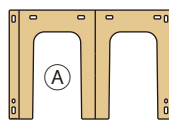

19枚

+

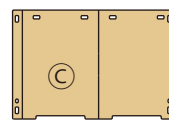

19枚



12マス

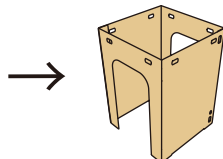

=

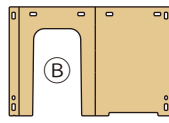

12枚

+

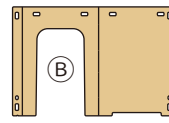

12枚



9マス

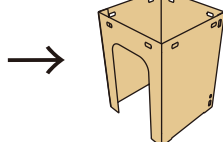

=

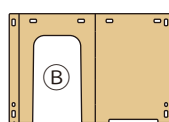

9枚

+

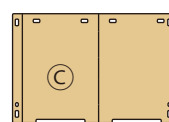

9枚

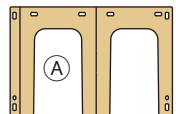

28枚+(予備1枚)

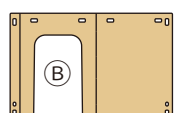

42枚+(予備1枚)

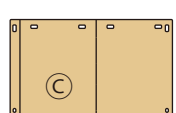

28枚+(予備1枚)

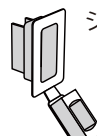

ジョイント
390個



タンボール
めいろ

7マス×7マス Cパターン 経路図

ゴール!!

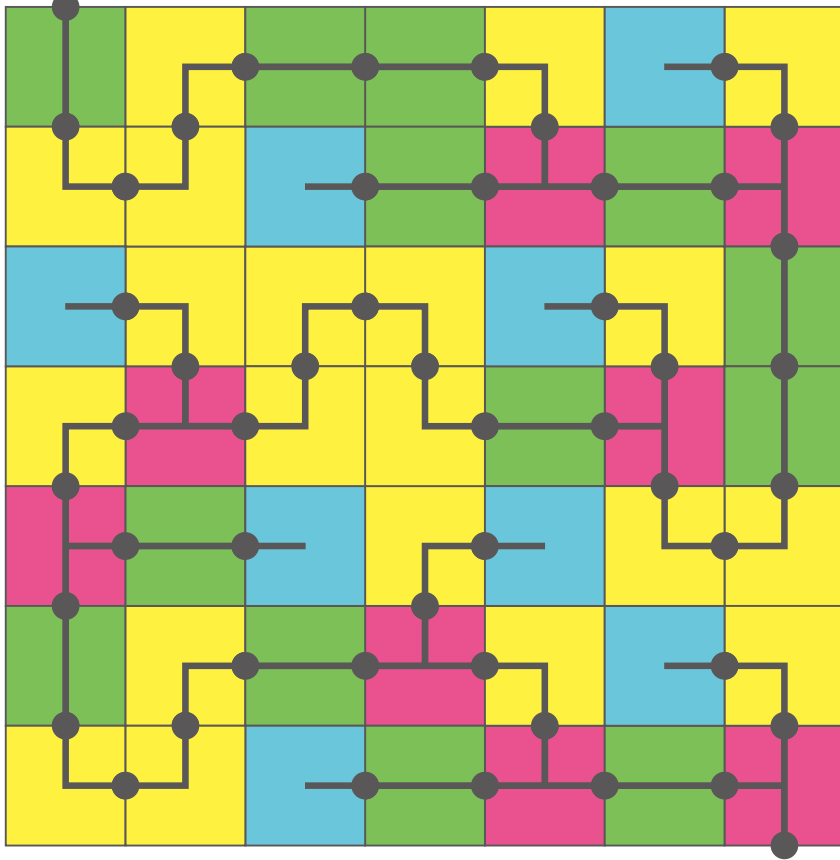

スタート!!

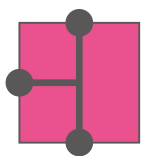

8マス

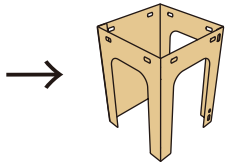

=

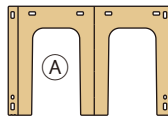

8枚

+

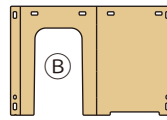

8枚



20マス

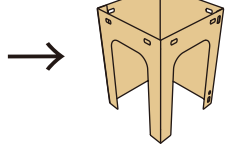

=

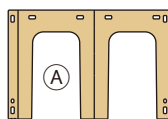

20枚

+

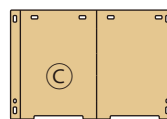

20枚



13マス

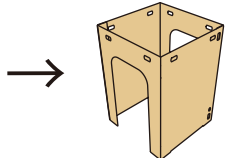

=

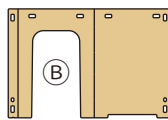

13枚

+

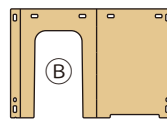

13枚



8マス

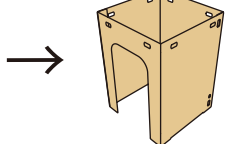

=

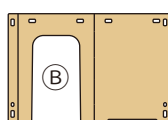

8枚

+

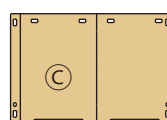

8枚

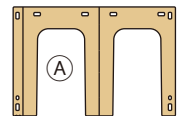

28枚+(予備1枚)

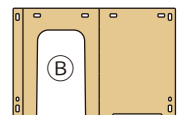

42枚+(予備1枚)

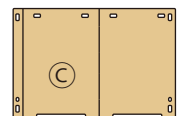

28枚+(予備1枚)

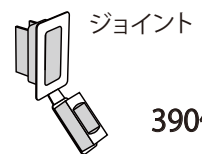

ジョイント

390個



タンボール
めいろ

7マス×7マス Dパターン 経路図

ゴール!!

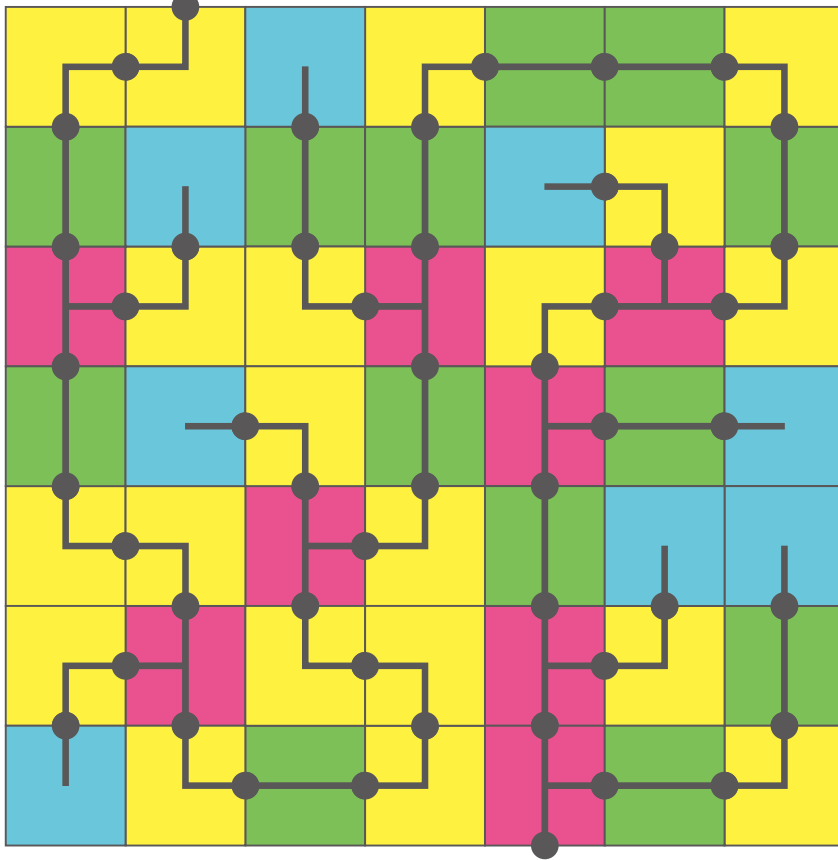

スタート!!

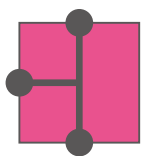

8マス

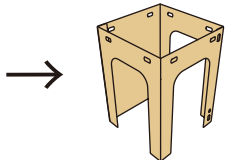

=

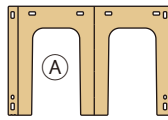

8枚

+

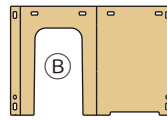

8枚

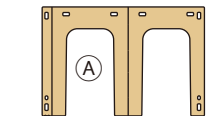

28枚+(予備1枚)

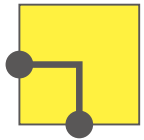

20マス

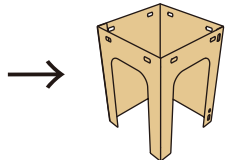

=

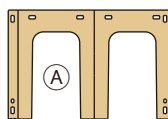

20枚

+

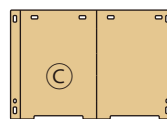

20枚

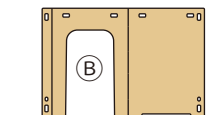

42枚+(予備1枚)



13マス

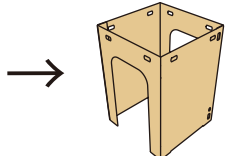

=

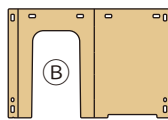

13枚

+

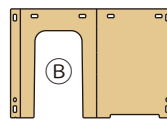

13枚

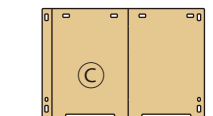

28枚+(予備1枚)



8マス

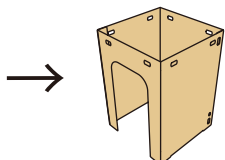

=

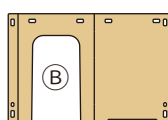

8枚

+

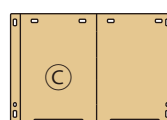

8枚



ジョイント

390個



7マス×7マス Eパターン 経路図

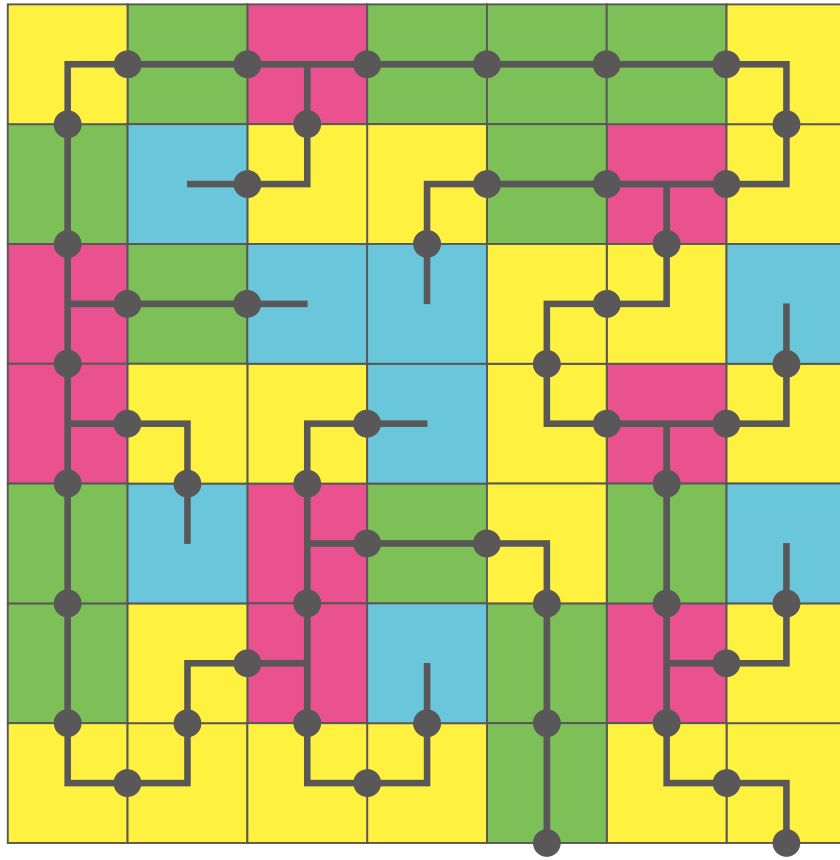

ゴール!! スタート!!

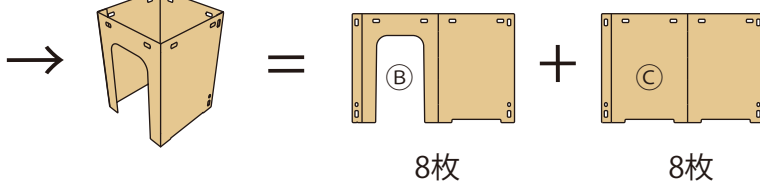
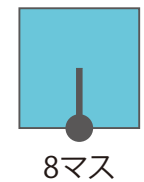
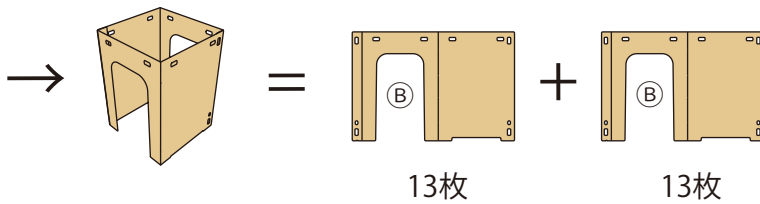
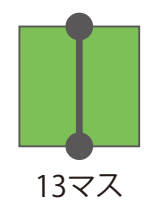
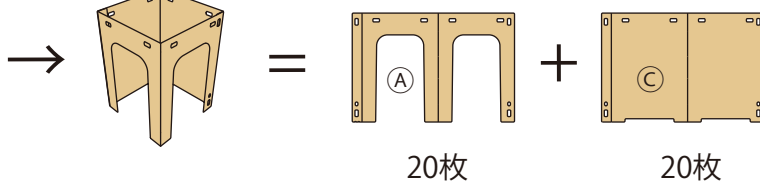
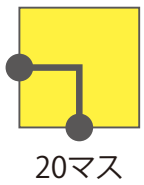
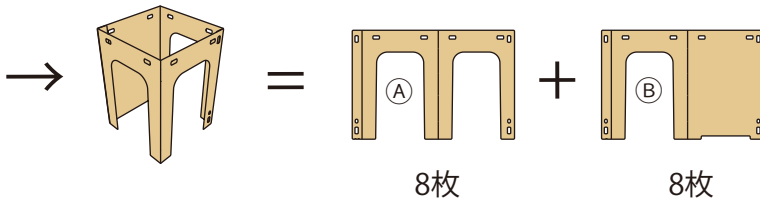
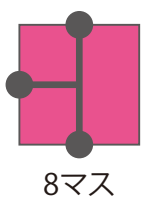

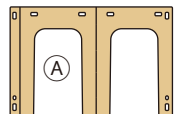

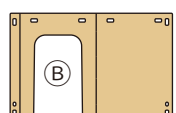

28枚+(予備1枚)

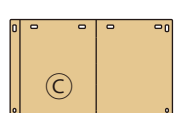

42枚+(予備1枚)



28枚+(予備1枚)



ジョイント
390個